

# 20

## Rotating fluids

The conductor of a carousel knows about fictitious forces. Moving from horse to horse while collecting tickets, he not only has to fight the centrifugal force trying to kick him off, but also has to deal with the dizzying sideways Coriolis force. On a typical carousel with a five meter radius and turning once every six seconds, the centrifugal force is strongest at the rim where it amounts to about 50% of gravity. Walking across the carousel at a normal speed of one meter per second, the conductor experiences a Coriolis force of about 20% of gravity. Provided the carousel turns anticlockwise seen from above, as most carousels seem to do, the Coriolis force always pulls the conductor off his course to the right. The conductor seems to prefer to move from horse to horse against the rotation, and this is quite understandable, since the Coriolis force then counteracts the centrifugal force.

The whole world is a carousel, and not only in the metaphorical sense. The centrifugal force on Earth acts like a cylindrical antigravity field, reducing gravity at the equator by 0.3%. This is hardly a worry, unless you have to adjust Olympic records for geographic latitude. The Coriolis force is even less noticeable at Olympic speeds. You have to move as fast as a jet aircraft for it to amount to 0.3% of a percent of gravity. Weather systems and sea currents are so huge and move so slowly compared to Earth's local rotation speed that the weak Coriolis force can become a major player in their dynamics. It is the Coriolis force which guarantees that weather cyclones on the northern half of the globe always turn anticlockwise around low pressure regions. For small scale flows, like that of a bathtub drain, its influence is tiny and cannot, contrary to myth, systematically determine the sense of the flow.

In this chapter we shall investigate the strange behaviors of fluids in rotating reference systems. At the end of the chapter we shall also debunk the persistent "urban legend" about the sense of rotation in toilets and bathtubs.

## 20.1 Fictitious forces

When dealing with a moving object, for example a rotating planet, it is often convenient to give up the inertial coordinate system and instead attach a fixed coordinate system to the moving object. If the object is neither accelerating nor rotating, the attached coordinate system is itself inertial, and the relativity of Newtonian mechanics then tells us that all physical laws take the same form. That is why there is no way of determining the absolute state of inertial motion in Newtonian mechanics. As mentioned before, this property of Newton's laws was extended to a fundamental principle for all of physics by Einstein in his special theory of relativity.

In a non-inertial, accelerated coordinate system, the Newtonian principle of relativity ceases to be valid, and the laws of mechanics take a different form. The acceleration on the left hand side of Newton's second law must be corrected by terms deriving from the motion of the coordinate system, and when these terms are shifted to the right hand side they may be interpreted as forces. Since these forces apparently have no objective cause, in contrast to forces caused by other bodies, they are called *fictitious*. A better name might be *inertial* forces, since there is nothing fictitious about the jerk you experience when the bus suddenly stops. In this chapter we shall only be concerned with steadily rotating coordinate systems, such as those we use on Earth.

### Steady rotation

Consider a Cartesian coordinate system  $(x, y, z)$  rotating with constant angular velocity  $\Omega$  around the  $z$ -axis relative to an inertial system  $(x', y', z')$ . The coordinates of a point particle are related by the transformation

$$x' = x \cos \Omega t - y \sin \Omega t , \quad (20-1a)$$

$$y' = x \sin \Omega t + y \cos \Omega t , \quad (20-1b)$$

$$z' = z . \quad (20-1c)$$

The transformation expresses as usual that the position of a point has a geometrically invariant meaning. The force  $\mathbf{F}'$  acting on the point particle in the inertial system, is related to the force  $\mathbf{F}$  in the rotating system by the same transformation,

$$F'_x = F_x \cos \Omega t - F_y \sin \Omega t , \quad (20-2a)$$

$$F'_y = F_x \sin \Omega t + F_y \cos \Omega t , \quad (20-2b)$$

$$F'_z = F_z , \quad (20-2c)$$

which expresses that force is a vector quantity. It is the only sensible way to define what is meant by force in the rotating system.

Newton's second law connects acceleration and force in the inertial system,

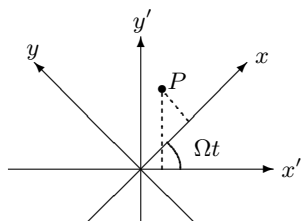

Transformation of coordinates of a point particle  $P$  from a rotating to an inertial coordinate system.

$md^2\mathbf{x}'/dt^2 = \mathbf{F}'$ . Differentiating (20-1) twice after  $t$  we find

$$\begin{aligned}\frac{d^2x'}{dt^2} &= \left(\frac{d^2x}{dt^2} - \Omega^2x - 2\Omega\frac{dy}{dt}\right)\cos\Omega t - \left(\frac{d^2y}{dt^2} - \Omega^2y + 2\Omega\frac{dx}{dt}\right)\sin\Omega t, \\ \frac{d^2y'}{dt^2} &= \left(\frac{d^2x}{dt^2} - \Omega^2x - 2\Omega\frac{dy}{dt}\right)\sin\Omega t + \left(\frac{d^2y}{dt^2} - \Omega^2y + 2\Omega\frac{dx}{dt}\right)\cos\Omega t, \\ \frac{d^2z'}{dt^2} &= \frac{d^2z}{dt^2}.\end{aligned}$$

Multiplying these equations with  $m$  and comparing with (20-2), the equations of motion in the rotating coordinates become,

$$\begin{aligned}m\left(\frac{d^2x}{dt^2} - \Omega^2x - 2\Omega\frac{dy}{dt}\right) &= F_x, \\ m\left(\frac{d^2y}{dt^2} - \Omega^2y + 2\Omega\frac{dx}{dt}\right) &= F_y, \\ m\frac{d^2z}{dt^2} &= F_z.\end{aligned}$$

At this point it is better to leave the particular coordinate system where the rotation vector points along the  $z$ -axis and write these equations in vector notation

$$m\left(\frac{d^2\mathbf{x}}{dt^2} + \boldsymbol{\Omega} \times (\boldsymbol{\Omega} \times \mathbf{x}) + 2\boldsymbol{\Omega} \times \frac{d\mathbf{x}}{dt}\right) = \mathbf{F}. \quad (20-3)$$

Clearly, the rotating coordinates have generated extra acceleration terms on the left hand side. Moving these terms to the right hand side, we obtain the standard expression for Newton's second law in a steadily rotating coordinate system,

$$\boxed{m\frac{d^2\mathbf{x}}{dt^2} = \mathbf{F} - m\boldsymbol{\Omega} \times (\boldsymbol{\Omega} \times \mathbf{x}) - 2m\boldsymbol{\Omega} \times \frac{d\mathbf{x}}{dt}}. \quad (20-4)$$

The extra terms on the right hand side now appear as fictitious forces: the *centrifugal force*  $-m\boldsymbol{\Omega} \times (\boldsymbol{\Omega} \times \mathbf{x})$  and *Coriolis force*  $-2m\boldsymbol{\Omega} \times d\mathbf{x}/dt$ .

In a general moving coordinate system, there are two further fictitious forces, the linear acceleration force  $-m\mathbf{a}(t)$  where  $\mathbf{a}(t)$  is the acceleration of the origin of the moving coordinate system, and the angular acceleration force  $-m d\boldsymbol{\Omega}/dt \times \mathbf{x}$ . The complete expression for Newton's second law in any moving Cartesian coordinate system thus becomes

$$m\frac{d^2\mathbf{x}}{dt^2} = \mathbf{F} - m\mathbf{a} - m\boldsymbol{\Omega} \times (\boldsymbol{\Omega} \times \mathbf{x}) - 2m\boldsymbol{\Omega} \times \frac{d\mathbf{x}}{dt} - m\frac{d\boldsymbol{\Omega}}{dt} \times \mathbf{x} \quad (20-5)$$

The extra fictitious forces are of no importance for the following discussion, but are derived by a general method in problem 20.1.

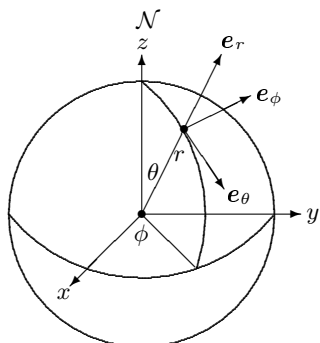

Spherical coordinates on Earth. The polar axis points towards the north pole, latitude is  $\delta = \pi/2 - \theta$  and longitude  $\lambda = -\phi$  is measured westwards from the zero meridian going through Greenwich, England.

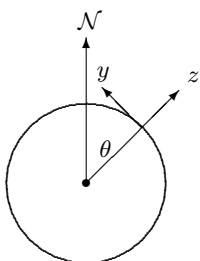

Local flat-earth coordinate system and its relation to the polar angle.

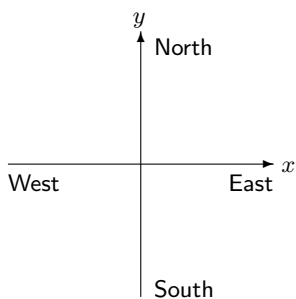

Flat-earth local coordinate system in a point on the surface.

## Centrifugal force on Earth

The effect of the centrifugal force on Earth is primarily to flatten the spherical shape in such a way that it conforms to an equipotential surface (see chapter 7). The direction of the combined gravitational and centrifugal force is always orthogonal to the equipotential surface everywhere on Earth, *i.e.* by definition vertical. The local vertical component of the centrifugal force becomes in Earth-centered polar coordinates for  $r = a$ ,

$$\mathbf{e}_r \cdot (-\boldsymbol{\Omega} \times (\boldsymbol{\Omega} \times \mathbf{x})) = a\Omega^2(\mathbf{e}_r \times \mathbf{e}_z)^2 = a\Omega^2 \sin^2 \theta, \quad (20-6)$$

where  $\theta$  is the polar angle. This is the amount by which local gravity is reduced by the centrifugal “antigravity”. The ratio of centrifugal acceleration to gravity is smaller than  $\Omega^2 a/g_0 \approx 3.5 \times 10^{-3}$  and thus generally negligible, except when precision is needed.

## Coriolis force on Earth

The Coriolis force is different. It acts along different directions in different places of the Earth, because the true rotation axis is not vertical, except at the poles. In a local flat-earth coordinate system tangential to the surface in a given point with the  $x$ -axis towards the east and the  $y$ -axis towards the north, the rotation vector is  $\boldsymbol{\Omega} = \Omega(0, \sin \theta, \cos \theta)$  where  $\theta$  is the polar angle. The components of the Coriolis acceleration  $\mathbf{g}^C = -2\boldsymbol{\Omega} \times \mathbf{v}$ , expressed in terms of the velocity  $\mathbf{v} = d\mathbf{x}/dt$ , are

$$g_x^C = 2\Omega \cos \theta v_y - 2\Omega \sin \theta v_z, \quad (20-7a)$$

$$g_y^C = -2\Omega \cos \theta v_x, \quad (20-7b)$$

$$g_z^C = 2\Omega \sin \theta v_x. \quad (20-7c)$$

At the poles the Coriolis force is always horizontal, and at the equator it is always vertical for horizontal motion ( $v_z = 0$ ). A good number to remember is the projection of Earth’s rotation on the local vertical at middle latitudes ( $\theta = 45^\circ$ ) which comes to  $2\Omega \cos \theta \approx 10^{-4} \text{ s}^{-1}$ .

The vertical Coriolis force  $g_z^C$  is very small compared to gravity. Even for a modern jet aircraft flying on an east-west course at middle latitudes at a speed close to the velocity of sound, it amounts to only about 0.3% of gravity, which accidentally is of the same order of magnitude as the centrifugal force. So we may happily ignore the vertical Coriolis force along with the centrifugal force in most Earthly considerations. We shall also ignore the Coriolis force due to the vertical component of velocity  $v_z$ . The jet plane from before experiences again only a Coriolis acceleration in westerly direction of magnitude 0.3% of gravity during upwards vertical flight at the speed of sound. For large scale systems, like weather cyclones, the horizontal motion is also by far the most important.

### Local angular velocity

The conclusion is that under normal circumstances only the first terms in  $g_x$  and in  $g_y$  need to be considered, leading to a purely two-dimensional Coriolis acceleration which we write in the form,

$$g_x^C = 2\Omega_\perp v_y , \quad (20-8a)$$

$$g_y^C = -2\Omega_\perp v_x , \quad (20-8b)$$

$$g_z^C = 0 . \quad (20-8c)$$

Here  $\Omega_\perp$  is the *local angular velocity*

$$\boxed{\Omega_\perp = \Omega \cos \theta} . \quad (20-9)$$

For all practical purposes, the Coriolis force in a local flat-earth coordinate system looks as if the Earth were indeed flat and rotated around the local vertical with the local angular velocity. The important part of the Coriolis force is thus in vector notation,

$$\mathbf{g}^C = -2\boldsymbol{\Omega}_\perp \times \mathbf{v} , \quad (20-10)$$

with  $\boldsymbol{\Omega}_\perp = \Omega_\perp \mathbf{e}_z$ . The magnitude of the local angular velocity at a given polar angle (or latitude) can be experimentally verified by means of a Foucault pendulum, an experiment which ought impress the members of the Flat Earth Society about the fallacy of their convictions.

The similarity of fictitious and gravitational forces is part of a much deeper equivalence between gravity and accelerated motion. Einstein raised it to a *Principle of Equivalence* stating that gravity locally, *i.e.* in sufficiently small regions of space and time, in all respects is indistinguishable from accelerated motion. But if that is the case, Mach then asked, why distinguish at all? Could inertial forces also be due to subtle gravitational effects of the mass distribution of distant fixed stars? Then inertial systems would be defined to be moving with constant velocity relative to the average motion of this distribution. This would in turn imply that inertial forces on Earth could depend on the presence of huge masses in our cosmic neighborhood, for example the center of the Milky Way, violating thereby the strict Equivalence Principle. No such effects have ever been observed, but the jury is still out [14].

## 20.2 Flow in a rotating system

In a steadily rotating coordinate system, the Navier-Stokes equations must also include the fictitious forces. The centrifugal force resembles the usual gravitational force and may be written as the gradient of a potential (7-13). Including this in the effective pressure (??), the Navier-Stokes equation for an incompressible fluid becomes,

$$\boxed{\frac{\partial \mathbf{v}}{\partial t} + (\mathbf{v} \cdot \nabla) \mathbf{v} = -\nabla \frac{p^*}{\rho_0} + \nu \nabla^2 \mathbf{v} - 2\boldsymbol{\Omega} \times \mathbf{v}} . \quad (20-11)$$

Provided the origin of the coordinate system resides on the axis of rotation, the effective pressure is

$$p^* = p + \rho_0 \Phi - \frac{1}{2} \rho_0 (\boldsymbol{\Omega} \times \mathbf{x})^2 . \quad (20-12)$$

As discussed in the preceding section, the centrifugal force can generally be ignored at the surface of the Earth, though not in laboratory experiments with rotating containers, such as Newton's bucket (page 121). The Coriolis force can also, at Earth's surface, be calculated to a good approximation from the vertical local angular velocity vector.

### The Rossby number

Let us again characterize the flow by a length scale  $L$  and a velocity scale  $U$ . For nearly ideal steady flow with large Reynolds number,  $\text{Re} = UL/\nu \gg 1$ , the advective term dominates the viscous term (except near boundaries). The interesting quantity is accordingly the ratio between the advective acceleration and the Coriolis acceleration, called the *Rossby number*

$$\text{Ro} = \frac{|(\mathbf{v} \cdot \nabla) \mathbf{v}|}{|2\boldsymbol{\Omega} \times \mathbf{v}|} \approx \frac{U^2/L}{2\Omega U} = \frac{U}{2\Omega L} . \quad (20-13)$$

For nearly ideal flow the Coriolis force is significant only if  $\text{Ro} \lesssim 1$ , or in other words  $U \lesssim 2\Omega L$ . Thus, the general rule is that the Coriolis force only matters, when the flow velocity  $U$  is of the same magnitude or smaller as the typical variation  $\pm\Omega L$  in the local rotation velocity across the system.

Ocean currents and weather cyclones are relatively steady phenomena. The characteristic speeds are meters per second for the ocean currents and tens of meters per second for the winds over distances of the order of thousand kilometers. The Reynolds number comes to about  $\text{Re} \approx 10^{12}$  in both cases, because the larger wind speeds are offset by the larger kinematic viscosity of air. The Rossby numbers are, however, different. With a local angular velocity  $2\Omega \approx 10^{-4}$  per second, one gets a Rossby number  $\text{Ro} \approx 0.01$  for ocean currents and  $\text{Ro} \approx 0.1$  for weather cyclones. Both of these phenomena are thus dominated by the Coriolis force, but the ocean currents by far the most.

**Example 20.2.1:** When you (of size  $L = 1$  m) swim with a speed of  $U \approx 1$  m s<sup>-1</sup>, the Rossby number becomes  $\text{Ro} \approx 10^4$ , and the Coriolis force can be completely neglected. The water draining out of your toilet or bathtub moves with similar speeds over similar distances, making the Rossby number just as large and the Coriolis force just as insignificant as for swimming (see also section 20.5). In a pool on a carousel rotating with  $\Omega \approx 1$  s<sup>-1</sup>, the Rossby number for swimming is  $\text{Ro} \approx 1$ , and you probably become quite dizzy. In space stations designed for long-term habitation, gravity must for health reasons be simulated by rotation, and the large Coriolis force will presumably play havoc with ping-pong and other ballistic games (see problem 20.2).

Carl-Gustav Arild Rossby (1898–1957). *Swedish born meteorologist who mostly worked in the US. Contributed to the understanding of large-scale motion and general circulation of the atmosphere.*

### The Ekman number

The ratio between viscous and Coriolis forces is called the *Ekman number*,

$$\text{Ek} = \frac{|\nu \nabla^2 \mathbf{v}|}{|2\boldsymbol{\Omega} \times \mathbf{v}|} \approx \frac{\nu U/L^2}{2\Omega U} = \frac{\nu}{2\Omega L^2} = \frac{\text{Ro}}{\text{Re}} . \quad (20-14)$$

When the Ekman number is small, the viscous force can be neglected relative to the Coriolis force. For large Reynolds number and moderate Rossby number, the Ekman number is automatically small. In natural systems on Earth, such as the sea and the atmosphere, the huge Reynolds number makes the Ekman number extremely small. The Ekman number is normally only of order unity close to boundaries where viscosity always comes to dominate over advection. Here the interplay between viscous and Coriolis forces gives rise to a highly interesting boundary layer, called the *Ekman layer* (section 20.4).

Vagn Walfrid Ekman (1874–1954). *Swedish physical oceanographer. Contributed to the understanding of dynamics of ocean currents.*

## 20.3 Geostrophic flow

In natural large-scale systems, the Reynolds number is so huge and the Rossby number so small that one can in the first approximation ignore both the viscous and the advective terms in the Navier-Stokes equations. A flow is said to be *geostrophic* if it is completely dominated by the Coriolis force. More formally, it is the limit of  $\text{Ro} \rightarrow 0$  and  $\text{Ek} \rightarrow 0$ .

Dropping both advective and viscous terms in (20-11), we arrive at the remarkably simple field equation for geostrophic flow,

$$\boxed{-\frac{1}{\rho_0} \nabla p^* - 2\boldsymbol{\Omega} \times \mathbf{v} = \mathbf{0}} . \quad (20-15)$$

It states that the effective pressure gradient must everywhere balance the Coriolis force. Inserting the effective pressure (20-12) and leaving out the contribution from the centrifugal force, this becomes

$$-\frac{1}{\rho_0} \nabla p + \mathbf{g} - 2\boldsymbol{\Omega} \times \mathbf{v} = \mathbf{0} , \quad (20-16)$$

an equation of basically the same form as the hydrostatic equation (4-18).

### Water level in an open canal

Let a constant water current with velocity  $U$  flow through a canal of width  $d$ . If the canal runs along the  $x$ -direction and the angular rotation is  $\Omega$  around the  $z$ -direction, we find from the  $y$ -component of (20-15)

$$\frac{1}{\rho_0} \frac{\partial p^*}{\partial y} = -2\Omega U . \quad (20-17)$$

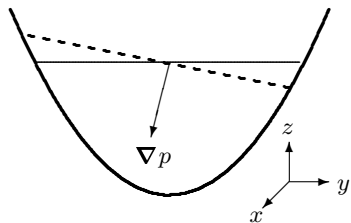

The water level is tilted by the Coriolis force, so that the surface stays orthogonal to the gradient of the true pressure. Here the Earth's rotation is positive around  $z$  and water flows out of the picture in the positive  $x$ -direction.

For positive  $\Omega$  and  $U$ , the Coriolis force wants to turn the water towards the right, creating an increasing effective pressure in the negative  $y$ -direction. Intuitively this seems to indicate that the Coriolis force will raise the water level for negative  $y$  and lower it for positive.

In order to check our intuition, we solve the above equation, making use of (20-12) with a gravitational potential  $\Phi = g_0 z$ , and get (apart from an unimportant constant)

$$\frac{p^*}{\rho_0} = \frac{p}{\rho_0} + g_0 z = -2\Omega U y . \quad (20-18)$$

The water level  $z = h(y)$  is determined from the requirement that the true pressure  $p$  should be constant at the free surface, so with the boundary condition  $h(0) = 0$  we get

$$h(y) = -\frac{2\Omega U}{g_0} y , \quad (20-19)$$

which confirms our intuition. In a north-south canal with the current running towards the north, the water level will be highest at the eastern bank.

**Example 20.3.1:** For a 10 km wide strait and a current velocity of 1 m/s, the difference in water level at the two sides of the strait due to the Coriolis force is about 10 cm. Although  $\text{Ro} = U/2\Omega d \approx 1$ , the use of the geostrophic equation (20-15) is nevertheless fully justified, because the inertial term vanishes for a constant flow in the  $x$ -direction (like for Poiseuille flow).

### Isobaric flow and weather maps

An immediate consequence of the geostrophic equation (20-15) is that

$$\mathbf{v} \cdot \nabla p^* = 0 , \quad (20-20)$$

which means that the effective pressure is constant along stream lines. In horizontal motion the gravitational force plays no role and the effective pressure is the same as the hydrostatic pressure. This means that *streamlines and isobars coincide in geostrophic flow*. This is also well-known from weather maps where wind directions can be read off from the isobars. To read off the correct sign for the wind direction one must also use that the Coriolis force make winds on the northern hemisphere turn anti-clockwise around low pressure regions (cyclones) and clockwise around regions with high pressure (anti-cyclones).

Quantitatively we we may invert the geostrophic equation (20-15) to calculate the wind velocities from the pressure gradients. Using that  $\boldsymbol{\Omega} \cdot \mathbf{v} = 0$  we find  $\boldsymbol{\Omega} \times (\boldsymbol{\Omega} \times \mathbf{v}) = -\Omega^2 \mathbf{v}$ , and then

$$\mathbf{v} = \frac{\boldsymbol{\Omega} \times \nabla p^*}{2\Omega^2 \rho_0} . \quad (20-21)$$

Were it not for the Coriolis force, air masses would stream along the negative pressure gradient, from high pressure towards low pressure regions. On the northern



hemisphere, the Coriolis force generates cyclones by making the air that streams towards the low pressure veer to the right until it gets aligned with the isobars, and — funnily enough — the same mechanism creates anticyclones.

### Two-dimensionality of geostrophic flow

The geostrophic equation (20-15) is an extremely serious constraint on the flow. Forming the scalar product with  $\boldsymbol{\Omega}$  we get

$$(\boldsymbol{\Omega} \cdot \nabla)p^* = \Omega \frac{\partial p^*}{\partial z} = 0 . \quad (20-22)$$

The effective pressure is evidently constant along the axis of rotation. In a constant gravitational field  $g_0$  anti-parallel with the axis of rotation, we may use (20-12) to obtain the hydrostatic pressure (ignoring again the centrifugal contribution)

$$p = p^*(x, y) - \rho_0 g_0 z , \quad (20-23)$$

just as we did in the case of the open canal.

The invariance under translations along the axis of rotation actually extends to the whole flow. To verify this, we calculate the  $\nabla \times$  of the geostrophic equation (20-15), using that the  $\nabla \times$  of a gradient vanishes.

$$0 = \nabla \times (\boldsymbol{\Omega} \times \mathbf{v}) = \boldsymbol{\Omega} \nabla \cdot \mathbf{v} - (\boldsymbol{\Omega} \cdot \nabla)\mathbf{v} = -(\boldsymbol{\Omega} \cdot \nabla)\mathbf{v} = -\Omega \frac{\partial \mathbf{v}}{\partial z} .$$

The flow field  $\mathbf{v}$  is consequently a function of  $x$  and  $y$  only. When the  $z$ -component  $v_z$  vanishes, the flow becomes entirely two-dimensional. This result is the *Taylor-Proudman theorem* (Proudman 1916). To the extent that weather cyclones satisfy the conditions for steady geostrophic flow, one may conclude that the same large-scale wind patterns are found all way up through the atmosphere [17].

The Taylor-Proudman theorem is a strange result, which predicts that if one disturbs the flow of a rotating fluid at, say,  $z = 0$ , then the pattern of the disturbance will, after all time-dependence has died away, have become copied to all other values of  $z$ . This is also true if the disturbance is caused by a three-dimensional object with finite extent in the  $z$ -direction. A so-called Taylor column (of disturbed flow) is created in the rotating fluid. Taylor columns are sometimes also called Proudman pillars.

The strangeness is however only in the mind, for many experiments beginning with Taylor's in 1923 have amply verified the existence of Taylor columns. Even a body moving steadily along the axis of rotation, such as a falling sphere, will push a long column of fluid in front of itself, and trail another behind. The mechanics underlying the formation of Taylor columns results from a complicated interplay between the inertial and viscous terms left out in the geostrophic equation (20-15), and it is not easy to give an explanation in simple physical terms (see for example [18]).

Geoffrey Ingram Taylor (1886–1975). *British physicist, mathematician and engineer. Had great impact on all aspects of 20'th century fluid mechanics from aircraft and explosions. Devised a method to determine the bulk viscosity of compressible fluids. Studied the movements of unicellular marine creatures.*

Joseph Proudman (1888–1975). *British mathematician and oceanographer. First proved the Taylor-Proudman theorem in 1915.*

## 20.4 The Ekman layer

Boundary layers arise around a body in nearly ideal flow, because viscous forces must necessarily come into play to secure the no-slip boundary condition. Steady boundary layers are normally asymmetric with respect to the direction of the slip-flow outside the layer, being thinnest at the leading edge of a body and thickening towards the rear. This happens even at an otherwise featureless body surface and may be understood as a cumulative effect of the slowing down of the fluid by the contact with the boundary. At a point downstream from the leading edge of a body, the fluid has been under the influence of shear forces from the boundary for a longer time than upstream and their effect have spread farther into the fluid. Boundary layers may, as discussed in chapter 25, even separate from the body and create a completely new flow pattern in the fluid at large.

A rotating fluid in geostrophic flow must also form boundary layers around the bodies immersed in it. For small bodies the effect of the rotation is negligible, but for larger bodies with flow velocity of the same scale as the local rotation speed, *i.e.* for  $\text{Ro} = U/2L\Omega \lesssim 1$ , the Coriolis force comes to play a major role in the formation of boundary layers. As the flow velocity rises from zero at the boundary to its asymptotic value in the geostrophic slip-flow outside the boundary, the Coriolis force becomes progressively stronger, making the flow veer more and more to the right (for anti-clockwise rotation). The geostrophic cross-wind effectively “blows away” accumulated fluid and prevents the downstream growth of the boundary layer. Such a boundary layer, confined to a finite thickness by the Coriolis force is called an *Ekman layer*.

One may estimate the thickness of the Ekman layer by comparing the Coriolis acceleration  $|2\boldsymbol{\Omega} \times \mathbf{v}| \approx 2\Omega U$  with the viscous acceleration  $|\nu \nabla^2 \mathbf{v}| \approx \nu U/\delta^2$  across the Ekman layer. Since they must be approximately equal in magnitude we get (apart from a numeric factor)

$$\delta \approx \sqrt{\frac{\nu}{\Omega}} \approx L\sqrt{\text{Ek}}, \quad (20-24)$$

where  $\text{Ek}$  is the value of the Ekman number (20-14) in the geostrophic flow outside the boundary layer. Notice that the estimate is independent of the velocity  $U$ . The Ekman layer has the same thickness everywhere even if the velocity of the geostrophic flow should vary from place to place.

### Shape of the Ekman layer

Outside the Ekman layer we assume that there is a steady geostrophic flow in the  $x$ -direction with velocity  $v_x = U$ , accompanied by an effective pressure  $p^*/\rho_0 = -2\Omega U y$  in the  $y$ -direction, as for canal flow (20-18). In looking for a solution which interpolates between the static boundary and the geostrophic flow, we again exploit the symmetry of the problem. As long as the centrifugal acceleration can be ignored, the equations of motion as well as the boundary conditions are independent of the exact position in  $x$  and  $y$ , *i.e.* invariant under

arbitrary translations in these coordinates. It is then natural to guess that there may be a maximally symmetric solution  $\mathbf{v} = \mathbf{v}(z)$  which is also independent of  $x$  and  $y$  and only depends on the height  $z$ .

With this assumption, mass conservation  $\partial v_z / \partial z = 0$  implies that the vertical velocity is a constant. Since it has to vanish on the non-permeable boundary  $z = 0$  it vanishes everywhere,  $v_z = 0$ . The flow in the transition layer is entirely two-dimensional, but varies with height  $z$ , and the Navier-Stokes equations become

$$\begin{aligned} 0 &= -\frac{1}{\rho_0} \frac{\partial p^*}{\partial x} + \nu \frac{d^2 v_x}{dz^2} + 2\Omega v_y, \\ 0 &= -\frac{1}{\rho_0} \frac{\partial p^*}{\partial y} + \nu \frac{d^2 v_y}{dz^2} - 2\Omega v_x, \\ 0 &= -\frac{1}{\rho_0} \frac{\partial p^*}{\partial z}. \end{aligned}$$

The inertial term automatically vanishes for the assumed form of the solution.

From the last equation it follows that the effective pressure is independent of height  $z$  and consequently must be everywhere equal to its terminal value  $p^*/\rho_0 = -2\Omega U y$  in the geostrophic flow outside the boundary layer. Inserting this result, the equations of motion now simplify to

$$\nu \frac{d^2 v_x}{dz^2} = -2\Omega v_y, \quad (20-25a)$$

$$\nu \frac{d^2 v_y}{dz^2} = -2\Omega(U - v_x). \quad (20-25b)$$

This is a pair of coupled homogenous differential equations for  $U - v_x$  and  $v_y$ . Solving the first for  $v_y$  and inserting it into the second, we get a single fourth order equation

$$\frac{d^4(U - v_x)}{dz^4} = -\frac{4\Omega^2}{\nu^2}(U - v_x).$$

The general solution to this linear fourth order differential equation is a linear combination of four terms of the form  $\exp(kz/\delta)$  where

$$\delta = \sqrt{\frac{\nu}{\Omega}}, \quad (20-26)$$

is the Ekman layer thickness parameter and  $k = \pm(1 \pm i)$  are the four roots of  $k^4 = -4$ . The roots with positive real part are of no use, because the solution then would grow exponentially for  $z \rightarrow \infty$ . Thus, the most general acceptable solution is

$$\begin{aligned} U - v_x &= A e^{-(1+i)z/\delta} + B e^{-(1-i)z/\delta}, \\ v_y &= i \left( A e^{-(1+i)z/\delta} - B e^{-(1-i)z/\delta} \right), \end{aligned}$$

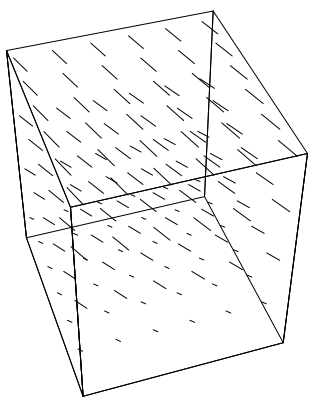

Ekman flow pattern in a vertical box. Notice how the fluid close to the ground flows to the left of the geostrophic flow higher up.

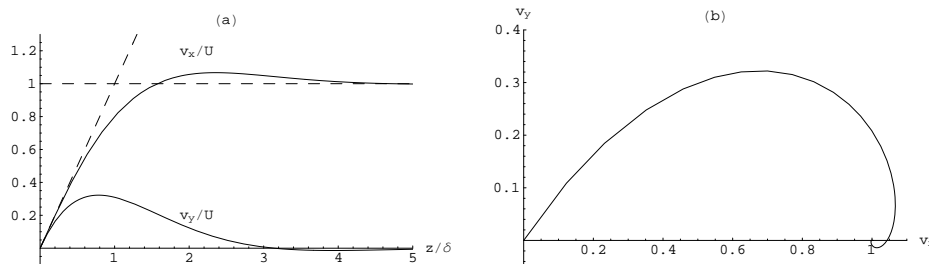

Figure 20.1: Plot of Ekman layer velocity components. (a) The velocity components as a function of height  $z$ . (b) Parametric plot of the velocities as a function of  $z$  leads to the characteristic Ekman spiral.

where we in the last equation have used (20-25a) to get  $v_y$ .

Applying the no-slip boundary condition,  $v_x = v_y = 0$  for  $z = 0$ , we find  $A = B = U/2$ , and the final solution becomes

$$\begin{aligned} v_x &= U \left( 1 - e^{-z/\delta} \cos z/\delta \right) , \\ v_y &= U e^{-z/\delta} \sin z/\delta . \end{aligned} \tag{20-27}$$

In fig. 20.1a the velocity components are plotted as a function of height. One notices that  $v_x$  first overshoots its terminal value, and then quickly returns to it. The  $y$ -component also oscillates but is  $90^\circ$  out of phase with the  $x$ -component. The direction of the velocity close to  $z = 0$  is  $45^\circ$  to the left of the asymptotic geostrophic flow. Plotted parametrically as a function of height, the velocity components create a characteristic spiral, called the *Ekman spiral*, shown in fig. 20.1b. The damping is however so strong that only the very first turn in this spiral is visible.

The presence of an Ekman layer of the right thickness has been amply confirmed by laboratory experiments. For the atmosphere at middle latitudes the thickness (20-26) becomes  $\delta = 56$  cm when the diffusive viscosity  $\nu = 1.57 \times 10^{-5}$  m<sup>2</sup>/s is used. This disagrees with the measured thickness of the Ekman layer in the atmosphere which is about 1000 m. The reason is that atmospheric flow tends to be turbulent rather than laminar with an effective viscosity that can easily be up to a million times larger than the diffusive viscosity[17]. We shall not go further into this question here.

### Displacement loss and cross-flow

The Ekman layer slows down the flow near the plate as does any boundary layer. The loss of volumetric discharge rate in the  $x$ -direction is normally compensated by an upflow from the boundary layer, but for the Ekman layer, this upflow is replaced by a net cross-flow in the  $y$ -direction. To verify this we calculate both

the loss in discharge rate along  $x$  and the cross-flow discharge rate along  $y$ , and find from (20-27)

$$\int_0^\infty (U - v_x) dz = \int_0^\infty v_y dz = \frac{1}{2} U \delta . \quad (20-28)$$

Both quantities are calculated per unit of length orthogonal to the flow. The equality of the loss in the  $x$ -direction with the gain in the  $y$ -direction may be seen as a quantitative explanation for the constant thickness of the Ekman layer as opposed to the growing thickness of non-rotating boundary layers.

### \* Upwelling and suction

The Ekman flow (20-27) may be rewritten in vector notation as

$$\mathbf{v} = \mathbf{U} \left( 1 - e^{-z/\delta} \cos z/\delta \right) + \mathbf{e}_z \times \mathbf{U} e^{-z/\delta} \sin z/\delta , \quad (20-29)$$

which should be valid for any choice of constant  $\mathbf{U}$ . If the geostrophic velocity vector  $\mathbf{U} = (U_x(x, y), U_y(x, y), U_z(x, y))$  actually changes slowly with  $x$  and  $y$  on a large scale  $L \gg \delta$  this expression should still be valid. The thickness (20-26) is as mentioned before independent of the velocity of the asymptotic geostrophic flow.

One would think that the  $z$ -independent vertical geostrophic upflow  $U_z$  should vanish, because it cannot penetrate into the ground at  $z = 0$ , but we shall now see that a varying geostrophic flow in fact generates a non-vanishing upflow from the Ekman layer. The derivative of the vertical flow component inside the Ekman layer may be calculated from mass conservation  $\nabla \cdot \mathbf{v} = 0$ , and we find from (20-27)

$$\frac{\partial v_z}{\partial z} = -\frac{\partial v_x}{\partial x} - \frac{\partial v_y}{\partial y} = \left( \frac{\partial U_y}{\partial x} - \frac{\partial U_x}{\partial y} \right) e^{-z/\delta} \sin z/\delta .$$

Here we have used that geostrophic flow also has to satisfy horizontal mass conservation  $\partial U_x/\partial x + \partial U_y/\partial y = 0$ . We recognize the factor in parenthesis on the right hand side as the vorticity  $\omega_z$  of the geostrophic flow. Integrating over  $z$  and using that  $v_z = 0$  for  $z = 0$ , we obtain

$$v_z = \frac{1}{2} \delta \left( \frac{\partial U_y}{\partial x} - \frac{\partial U_x}{\partial y} \right) \left[ 1 - e^{-z/\delta} (\cos z/\delta + \sin z/\delta) \right] , \quad (20-30)$$

an equation which is most easily verified by differentiation. Evidently, the vertical velocity is of size  $U\delta/L$ , which is always smaller than the geostrophic flow  $U$  by a factor  $\delta/L \ll 1$ .

For  $z \gg \delta$ , there remains a vertical component in the asymptotic geostrophic flow

$$\boxed{U_z = \frac{1}{2} \delta \left( \frac{\partial U_y}{\partial x} - \frac{\partial U_x}{\partial y} \right)} . \quad (20-31)$$

Since it is independent of  $z$ , it is not at variance with the geostrophic nature of the exterior flow or the Taylor-Proudman “vertical copy” theorem.

If the geostrophic vorticity  $\omega_z = \partial U_y / \partial x - \partial U_x / \partial y$  is positive, *i.e.* of the same sign as the global rotation, fluid wells up from the Ekman layer (without changing its thickness). This is, for example, the case for a low-pressure cyclone, where the upwelling of fluid must be accompanied by a cross-isobaric flow inside the Ekman layer towards the center of the cyclone. Conversely if the geostrophic vorticity is negative, as in high-pressure anticyclones, fluid is sucked down into the Ekman layer from the geostrophic flow. Both of these effects tend to equalize the pressure between the center and the surroundings of these vast vortices.

## 20.5 Steady vortex in rotating container

In the laboratory, gravity-sustained vortices may be created by letting a liquid, typically water, run freely out through a small drain-hole in the center of a slowly rotating cylindrical container. The liquid lost through the drain is constantly pumped back into the container. In the steady state the pump provides the kinetic energy of the falling liquid, and its angular momentum is provided by the motor rotating the container. The container is drained through a very small hole of radius  $r = a$ . We shall for simplicity disregard the influence of the outer container wall at  $r = A$ , and thus think of the container as having infinite radius.

In the following we shall repeatedly refer to the experiment shown in fig. 20.2 (with the parameters given in the figure caption)<sup>1</sup>. In this experiment, a steady flow pattern with a beautiful central vortex gets established after about half an hour. The vortex is remarkably stable and its flow can be studied experimentally by modern imaging techniques. The needle-like central depression is accompanied by a very rapid central rotation of at least 50 turns per second, or 3000 rpm, which is as fast as a typical medium-sized car engine rotates at a cruising speed of 100 km/h!

Experimentally, the bulk of the vortex outside the surface depression is found to have the shape of a line vortex with azimuthal velocity,  $v_\phi = C/r$  in the rotating coordinate system of the container. The azimuthal Reynolds number of the line vortex is independent of  $r$ ,

$$\text{Re}_\phi = \frac{rv_\phi}{\nu} = \frac{C}{\nu}, \quad (20-32)$$

and in the experiment it has the value  $\text{Re}_\phi \approx 1600$ , somewhat below the onset of turbulence.

<sup>1</sup>A. Andersen, T. Bohr, B. Lautrup, J. J. Rasmussen, and B. Stenum, “Bathtub vortex flows with a free surface”

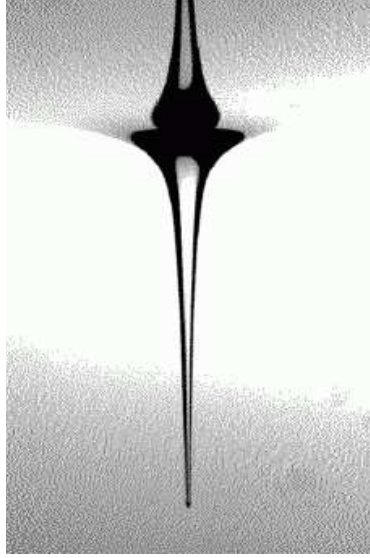

Figure 20.2: *Water vortex in a rotating container. The upper part is the reflection of the vortex in the water surface. The radius of the drain-hole is  $a = 1$  mm, the radius of the container is  $A = 20$  cm, the asymptotic water level is  $L = 11$  cm, and the whole apparatus rotates at  $\Omega = 18$  rpm. After about 30 minutes the vortex stabilizes with a central dip of  $L - h_0 = 6$  cm, or  $h_0 = 5$  cm. The volume discharge through the drain is measured to be  $Q = 3.16 \text{ cm}^3 \text{ s}^{-1}$  corresponding to an average drain velocity of  $W = 101 \text{ cm s}^{-1}$  and a Reynolds number  $\text{Re}_z = 2328$ . The circulation constant is  $C = 16.0 \text{ cm}^2 \text{ s}^{-1}$ , and the Rossby radius  $R = 2.9$  cm. The core rotates more 50 times per second!*

### Rossby radius

The local Rossby number of the line vortex at a distance  $r$  from its axis is,

$$\text{Ro} = \frac{v_\phi}{2\Omega r} = \frac{C}{2\Omega r^2} \quad (20-33)$$

It decreases rapidly with growing  $r$  and drops below unity for  $r \gtrsim R$  where

$$R = \sqrt{\frac{C}{2\Omega}}. \quad (20-34)$$

We shall call this the *Rossby radius*, and in the experiment of fig. 20.2 we find  $R = 2.1$  cm. Well inside the Rossby radius for  $r \ll R$ , the Coriolis force is small compared to the advective force, and the vortex will resemble the bathtub vortices discussed in chapter 23, except that there is upflow from the Ekman layer outside the drain proper. At the other extreme, well beyond the Rossby radius for  $r \gg R$ , the flow will be purely geostrophic.

### Cylindrical geostrophic flow

The Taylor-Proudman “copycat” theorem guarantees that in the geostrophic regime, the flow cannot depend on the vertical height  $z$ . Assuming further that the flow is cylindrical, it follows that the velocity components in cylindrical coordinates,  $v_{r,\phi,z}$ , are only functions of  $r$ . The geostrophic equation (20-16) now decomposes into the three equations,

$$\frac{1}{\rho_0} \frac{\partial p}{\partial r} = 2\Omega v_\phi , \quad (20-35a)$$

$$\frac{1}{\rho_0} \frac{\partial p}{\partial \phi} = -2\Omega v_r , \quad (20-35b)$$

$$\frac{1}{\rho_0} \frac{\partial p}{\partial z} = -g_0 . \quad (20-35c)$$

By the usual argument, the uniqueness of the pressure forbids any  $\phi$ -dependence, so that the second equation leads to  $v_r = 0$ . The pressure can then be obtained by integrating the two other equations. Notice that whereas the radial flow always has to vanish, we find apparently no restrictions on the azimuthal flow  $v_\phi$  or the upflow  $v_z$ . In particular, it does not follow from this argument that the azimuthal flow takes the form of a line vortex.

The main conclusion is, that *geostrophic flow can never carry any inflow towards the drain*. This is in fact equivalent to the previously derived result that flow lines and isobars coincide in geostrophic flow. The only way inflow can occur is through deviations from clean geostrophic flow, and that happens primarily inside the Rossby radius and close to the bottom of the container, where an Ekman layer must form.

### The Ekman layer valve

In the preceding section we saw that the asymptotic upflow from the Ekman layer (20-31) is controlled by the vorticity of the geostrophic flow. Since the Taylor-Proudman theorem guarantees that the upflow is independent of  $z$ , and since there can be no geostrophic inflow, this upflow will unabated reach the nearly horizontal open surface at top of the vortex. But there it has nowhere to go<sup>2</sup>, so the only possibility that remains is for the vorticity of the geostrophic flow to vanish, and this is only possible for a line vortex,  $v_\phi = C/r$ . It is essentially the presence of an open surface that forces the flow to be that of a line vortex.

The constant thickness of the Ekman layer

$$\delta = \sqrt{\frac{\nu}{\Omega}} \quad (20-36)$$

comes to merely 0.7 mm in the experiment (fig. 20.2). The radial volume discharge can now be calculated from the cross-flow in (20-28) by taking  $U = C/r$

<sup>2</sup>To complete the argument, one also has to verify that the Ekman layer which will also form at the upper open surface is incapable of diverting any large upflow towards the drain.



and multiplying with the length of the circumference,  $2\pi r$ , to get the constant radial discharge rate,

$$Q = \pi C \delta . \quad (20-37)$$

This is a fundamental result which connects the primary circulating flow with the secondary inflow towards the drain. The Ekman layer in effect acts as a valve that only allows a certain amount of fluid to flow towards the drain per unit of time.

Alternatively, one can use this relationship to calculate the circulation constant  $C$  from the more easily measured drain-flow  $Q$ . In the experiment of fig. 20.2 where the drain flow is measured to be  $Q = 3.16 \text{ cm}^3/\text{s}$ , we predict  $C = 15 \text{ cm}^2 \text{ s}^{-1}$  which is in good agreement with the measured value  $C = 16.0 \text{ cm}^2 \text{ s}^{-1}$ . If at all significant, the discrepancy could be caused by the finite size of the container.

### Inner vortex

Inside the Rossby radius the non-linear advective forces take over, but there will still exist a thin — in fact thinner — Ekman-like layer close to the bottom. But even if the circulating primary flow is that of a line vortex, the non-linearities will now cause an upwelling of fluid from the bottom layer. The bulk flow is no more geostrophic, so there is no injunction against the upflow turning into an inflow directed towards the center of the vortex. Thus, the general picture is that the secondary flow creeps inwards along the bottom through the Ekman layer outside the Rossby radius, flares up vertically from the bottom inside and turns towards the center in the bulk, for finally to dive sharply down into the drain. Along its way it carries energy and angular momentum to sustain the primary vortex flow.

Modelling of the inner vortex, in particular the core region near the drain, is a rather complex task. The main difficulty lies in matching the upflow from the bottom layer to the bulk flow. The narrow drain, the thin Ekman-like bottom layer, and the very high rotation speeds in the vortex core, in excess of 50 cps for the case of fig. 20.2, makes the differential equations “stiff” and numerically unwieldy. Surface tension will also influence the needle-like depression and make it less needle-like, but this effect has yet to be properly included.

Concluding the discussion of the vortex in a rotating container, it appears that even if the experiment is fairly easy to set up, the physics is extremely varied in different regions. The only perfectly understood region is the bulk-flow outside the Rossby radius, not too close to the outer container wall, and the associated bottom Ekman layer. The inner vortex may be modelled as a cylindrical vortex, but its coupling to the bottom layer is not well understood. The central core acts as a pipe, funnelling fluid towards the drain, but the shape of the open surface of the needle-like depression is still not fully understood, especially what concerns the influence of surface tension.

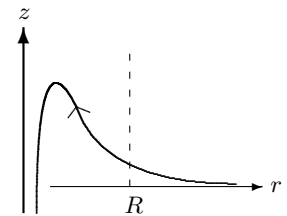

*Typical flowline for fluid streaming in through the Ekman layer outside the Rossby radius  $R$ , welling up inside  $R$  and finally falling through the drain.*

## 20.6 Debunking an urban legend

Finally, we turn to the “urban legend” concerning the direction of rotation of real bathtub vortices and their dependence on the Earth’s rotation. The legend originates in the correct physical theory of the Coriolis force, amply confirmed by the everyday observation of weather cyclones. So the urban legend can only be debunked by quantitative arguments, usually not given much attention in urban circles.

Suppose to begin with that our bathtub is essentially infinitely large and that the water level is  $L = 50$  cm. Bernoulli’s theorem tells us that the drain velocity is at most  $W = \sqrt{2g_0L} \approx 300$  cm s<sup>-1</sup>. Taking the drain radius to be  $a = 2.5$  cm, the maximal drain discharge rate becomes  $Q \approx 6$  liter s<sup>-1</sup>. This seems not unreasonable for bathtubs that typically contain hundreds of liters of water (and excessively waste both water and heat!). Assuming furthermore that the flow is perfectly laminar, we find the Ekman thickness  $\delta = 14$  cm, and from (20-37) we get  $C = 140$  cm<sup>2</sup>/s, corresponding to a Rossby radius of  $R = 17$  m. Most bathtubs are not that big and this shows that Earth’s rotation can only have little influence on a real bathtub vortex, in spite of the many claims to the contrary. A swimming pool of Olympic dimensions is on the other hand of the right scale. What matters for the man-sized bathtub is much more, as we discussed in chapter 23, the bather’s accidental deposition of angular momentum in the water while getting out.

There is, however, the objection that the effect of the Earth’s rotation could show up, if the water were left to settle down for some time before the plug is pulled. For that to happen, the Rossby number (20-13) would have to be comparable to unity. Taking the diameter of a real tub to be  $A \approx 1$  m, this implies that the water velocity near the rim of the tub should not be much larger than  $\Omega A \approx 5 \times 10^{-3}$  cm/s. This seems terribly small, about the thickness of a human hair per second!

The following argument indicates what patience is needed to make an experiment<sup>3</sup>. After the initial turbulence from filling the tub has died out, we shall assume that the water settles down under the action of viscous forces (although the Reynolds number for a flow with the above velocity is still about 60). Viscosity not only smoothes out local velocity differences but also secures that the fluid eventually comes to rest with respect to the container. The typical viscous diffusion time over a distance  $d$  is  $t \approx d^2/4\nu$ , as we have seen for momentum diffusion on page 337 or vortex spin-down on page 478. In a bathtub with a water level of  $L = 50$  cm, the time it takes for the bottom of the container to influence the water at the top is about  $t \approx 75,000$  s or about 20 hours! To make the experiment work, you must not only let the water settle for a few times 20 hours, but also secure that no heat is added to the water (which may generate convection), and no air drafts are present in and around the container.

<sup>3</sup>Some experimenters *are* patient and careful enough to observe the effect. See for example the very enjoyable paper by L. M. Trefethen et al, Nature **207**, 1084 (1965).

## Problems

**20.1** Write the inertial coordinates in terms of the unit vectors along the axes of the moving coordinate system,  $\mathbf{x}' = x\mathbf{e}_x + y\mathbf{e}_y + z\mathbf{e}'_z$ , and use that the time derivative of the unit vectors may always be written  $\dot{\mathbf{e}}_x = \boldsymbol{\Omega} \times \mathbf{e}_x$ ,  $\dot{\mathbf{e}}_y = \boldsymbol{\Omega} \times \mathbf{e}_y$ , and  $\dot{\mathbf{e}}_z = \boldsymbol{\Omega} \times \mathbf{e}_z$ . Find and characterize all the fictitious forces due to rotation.

**20.2** The space station is ??? in diameter. a) Calculate the angular velocity necessary to obtain Earth gravity at the outer rim. b) Estimate the Coriolis deflection of a typical ping-pong ball.

**20.3** In the Danish Great Belt, which is a strait with a width of 20 km, the typical current velocity is 1 m/s, there are two layers of water, a lower and slower saline layer with a lighter brackish one on top. Assuming a density difference of about 4% and a velocity difference of about 25%, calculate the difference in water levels for the separation surface between saline and brackish water.

